

1 Hängerahmen Einzelteile

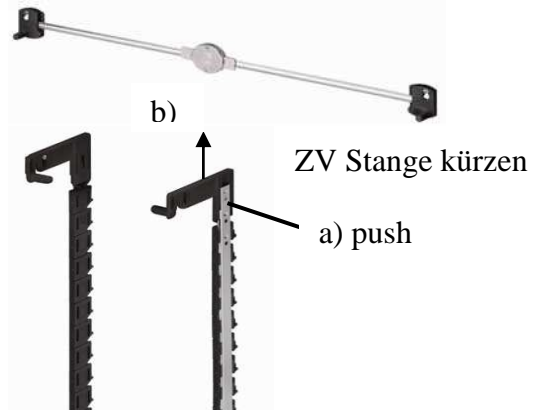

2 Schliesssystem Einzelteile
 ZV Stange Raster32mm 2HE kürzbar
 ZV Stange Raster25mm 2,5HE kürzbar



3 Montage hinter fester Schlossblende

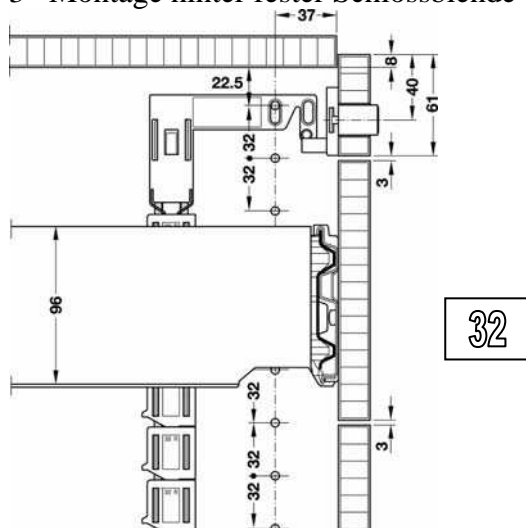

4 Montage hinter fester Schlossblende

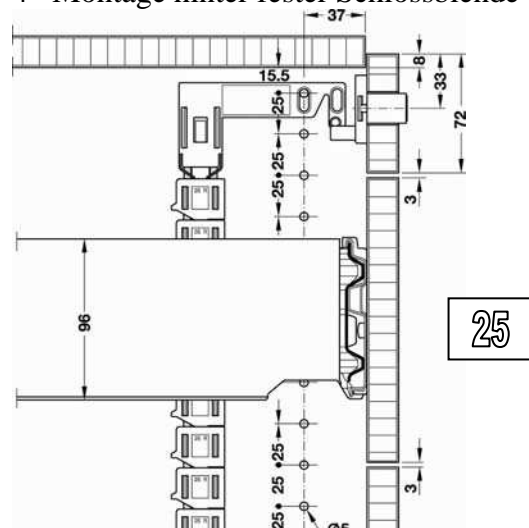

5 Ausziehperre hinter Türen

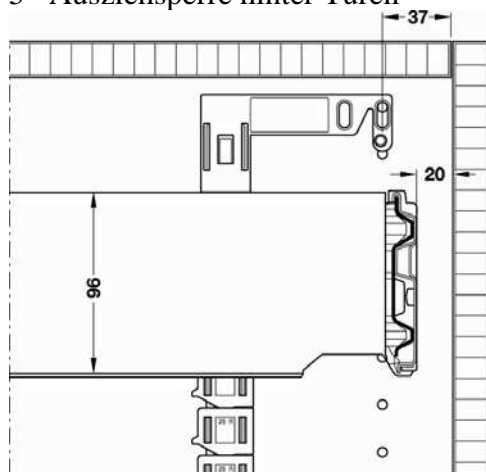

6 Bohrmaße für Schubstangenschloß

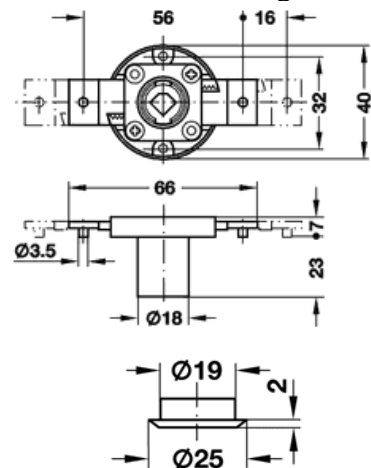

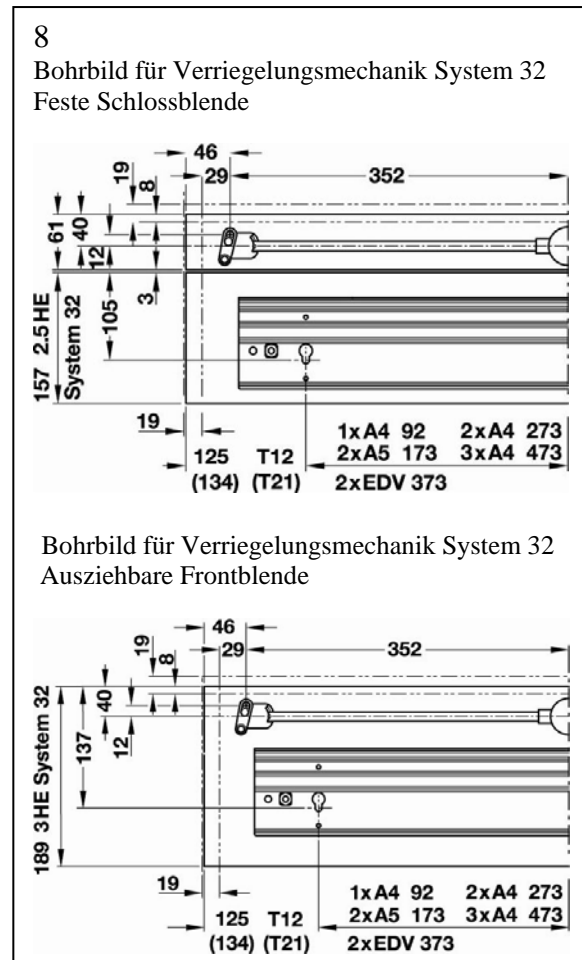
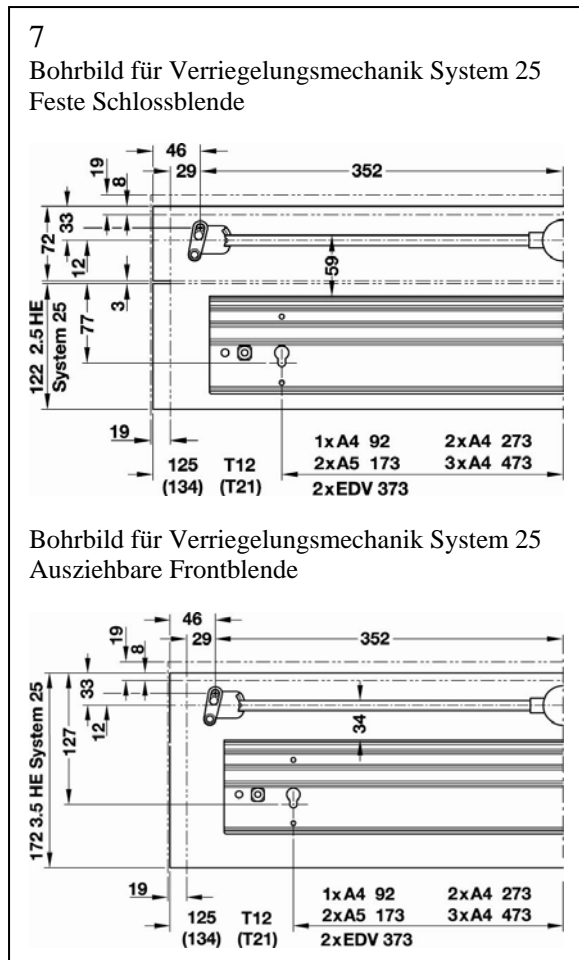

Berechnung für Bohrposition Schwenkelemente:

(Einbaubreite - 58mm) / 2
z.B. (762mm-58mm) / 2 = 352

Berechnung der Schubstangenlänge L:

Einbaubreite / 2 - 67mm = L
z.B. 762mm / 2 = 381mm - 67mm = 314mm

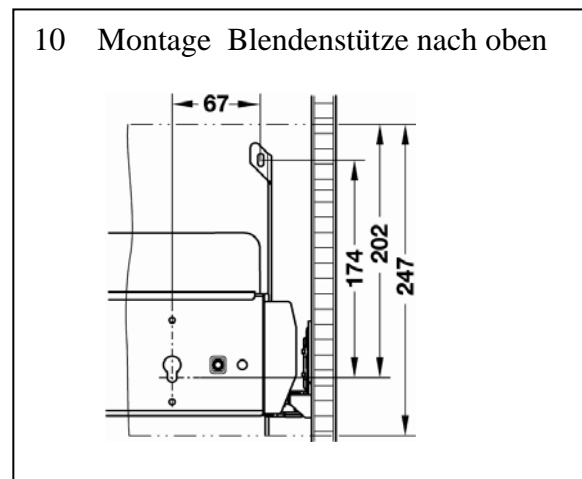
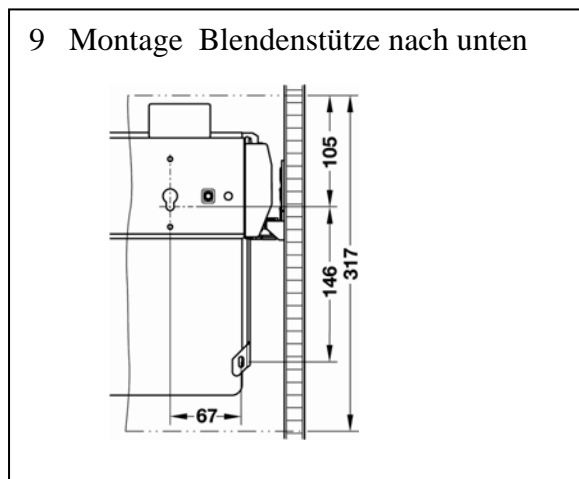
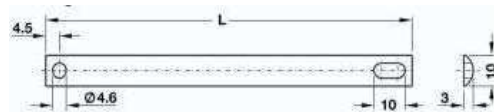

11 Kragenschrauben eindrehen

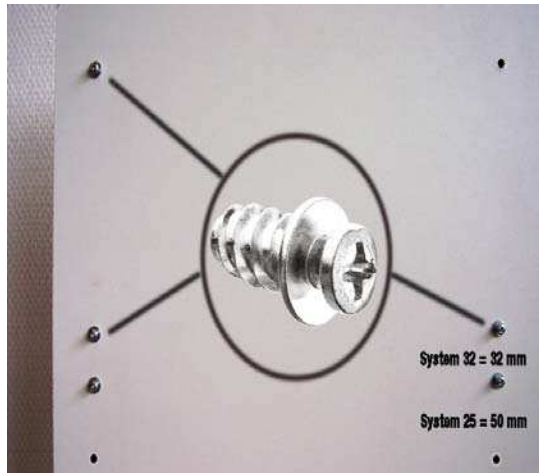

12 ZV Stange aufclipsen

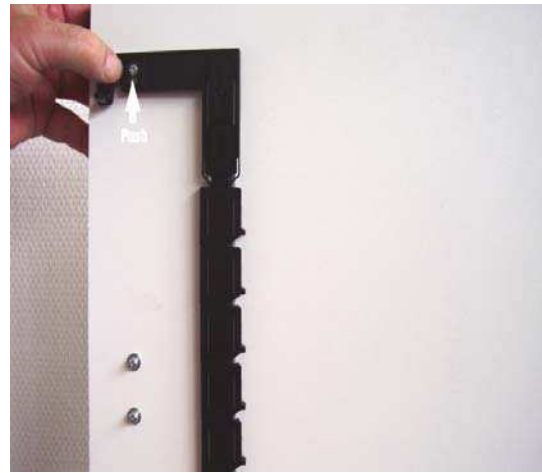

13 optional - Dämpfer einclipsen

a) Führung ausziehen

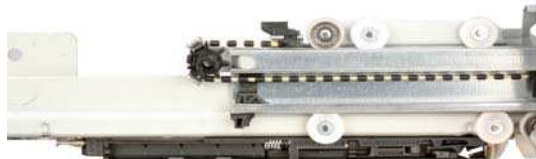

b) Einzugsэлемент in geschlossene Stellung bringen

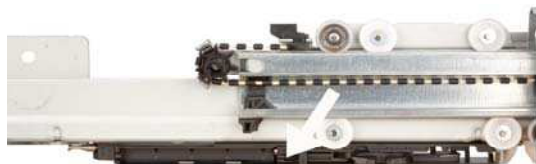

c) Dämpfer mit überstehender Lasche nach unten positionieren



d) Dämpfer in Gehäuse einclipsen

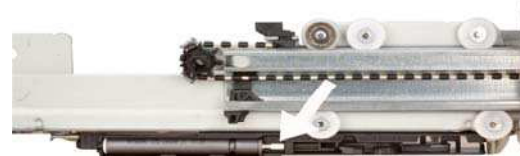

14 Führung einhängen



15 Parallelsteuerung einclipsen

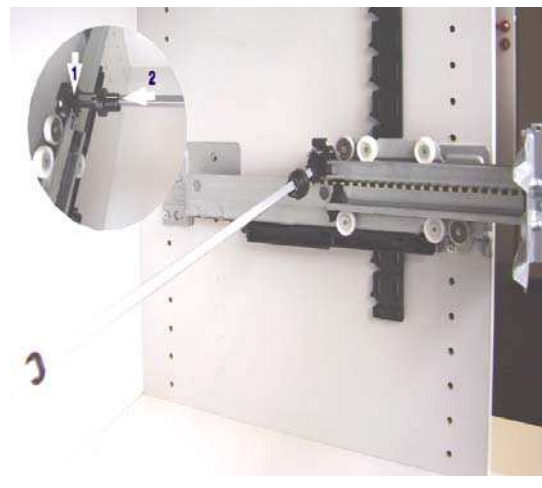

16 Vorwandblende einhängen und verschrauben

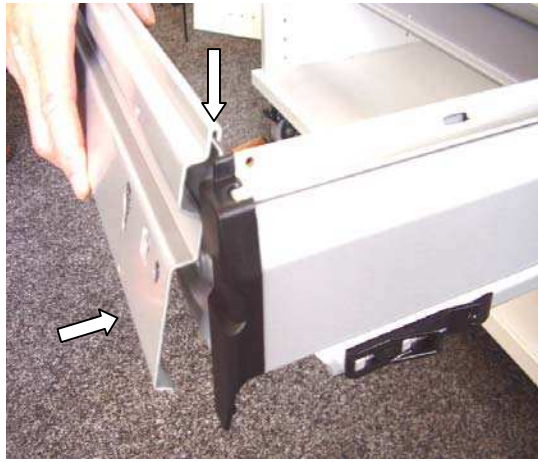

17 optional - Einlegeboden von hinten einschieben



18 Rückwandblende einhängen und verschrauben



19 Hängerahmen montiert



Demontagehinweis: Montageschritte von 18 bis 11 zurück

14 Sicherung anheben , Führung aushängen

